

STEEL BUILDINGS IN EUROPE

Single-Storey Steel Buildings

Part 1: Architect's Guide

Single-Storey Steel Buildings

Part 1: Architect's Guide

FOREWORD

This publication is part one of the design guide, *Single-Storey Steel Buildings*.

The 11 parts in the *Single-Storey Steel Buildings* guide are:

- Part 1: Architect's guide
- Part 2: Concept design
- Part 3: Actions
- Part 4: Detailed design of portal frames
- Part 5: Detailed design of trusses
- Part 6: Detailed design of built up columns
- Part 7: Fire engineering
- Part 8: Building envelope
- Part 9: Introduction to computer software
- Part 10: Model construction specification
- Part 11: Moment connections

Single-Storey Steel Buildings is one of two design guides. The second design guide is *Multi-Storey Steel Buildings*.

The two design guides have been produced in the framework of the European project "Facilitating the market development for sections in industrial halls and low rise buildings (SECHALO) RFS2-CT-2008-0030".

The design guides have been prepared under the direction of Arcelor Mittal, Peiner Träger and Corus. The technical content has been prepared by CTICM and SCI, collaborating as the Steel Alliance.

Contents

	Page No
FOREWORD	i
SUMMARY	v
1 INTRODUCTION	1
1.1 Steel as a construction material	1
1.2 Steel in single storey buildings	7
2 ADVANTAGES OF CHOOSING A STEEL STRUCTURE	8
2.1 Low weight	8
2.2 Minimum construction dimensions	9
2.3 Speed of construction	9
2.4 Flexibility and adaptability	10
2.5 A sustainable solution	11
3 FORM OF PRIMARY STEEL STRUCTURE	12
3.1 Structure types	12
3.2 Connections between columns and beams	26
4 BUILDING ENVELOPE	28
4.1 Cladding systems	29
4.2 Secondary steelwork	30
4.3 Roofs	30
5 FIRE SAFETY	33
6 OVERHEAD CRANES	34
7 CONCLUSIONS	36
8 FURTHER READING	37

SUMMARY

This publication presents an introduction for architects to the use of steel in single storey steel-framed buildings. The primary application of such buildings is for industrial use but single storey solutions are appropriate for many other applications. The advantages of the use of steel, in terms of low weight, minimum construction dimensions, speed of construction, flexibility, adaptability and sustainability are explained. The primary forms of steel structure and the methods of cladding them are introduced. It is noted that the requirements for fire resistance are usually modest, since occupants can usually escape quickly in the event of fire. The influence of providing a crane inside a single storey building, in terms of the structural design, is briefly addressed.

1 INTRODUCTION

1.1 Steel as a construction material

Steel is synonymous with modern architecture. Throughout the twentieth century, the material has inspired architects and engineers, for it combines strength and efficiency with unparalleled opportunities for sculptural expression.

The key attribute of steel is its high strength to weight ratio, which gives remarkable spanning and load carrying ability. Steel lends itself to prefabrication. Whole structures can be created in a factory environment and then constructed quickly on site. Steel buildings are highly adaptable, in that frames can be modified and altered. Costs are low, recycling simple and aesthetic opportunities rich and varied. As designers, fabricators and constructors continually advance the boundaries of steel design, both technically and expressively, steel has a crucial role in modern architecture.

Steel is basically a simple alloy of iron and carbon, but its properties can be enhanced and modified by the addition of other alloying elements and by the manufacturing process. The material is then made into sections, plate, or sheet, and these simple products used to produce structures and building components.

Standard approaches have evolved for many types of single storey structures but they are not constraining: departures from norms are commonplace, for steel lends itself to creative solutions. Modern architecture is rich with solutions that defy simple categorization, even in single storey structures. These do not have to be utilitarian. They can be formed into gentle arcs or startling expressed structure. Although greatest economy is often achieved with regular grids and standardization, steel structures offer outstanding opportunity for architectural expression and outstanding design opportunities. Some illustrations of the dramatic structural forms that are possible in steel construction are shown in Figure 1.1 to Figure 1.5.



Figure 1.1 Single storey structure with curved roof



Figure 1.2 Single storey warehouse with exposed steelwork truss



Figure 1.3 Single storey curved and cranked steelwork for an art gallery



Figure 1.4 Modern industrial building with curved steel roof

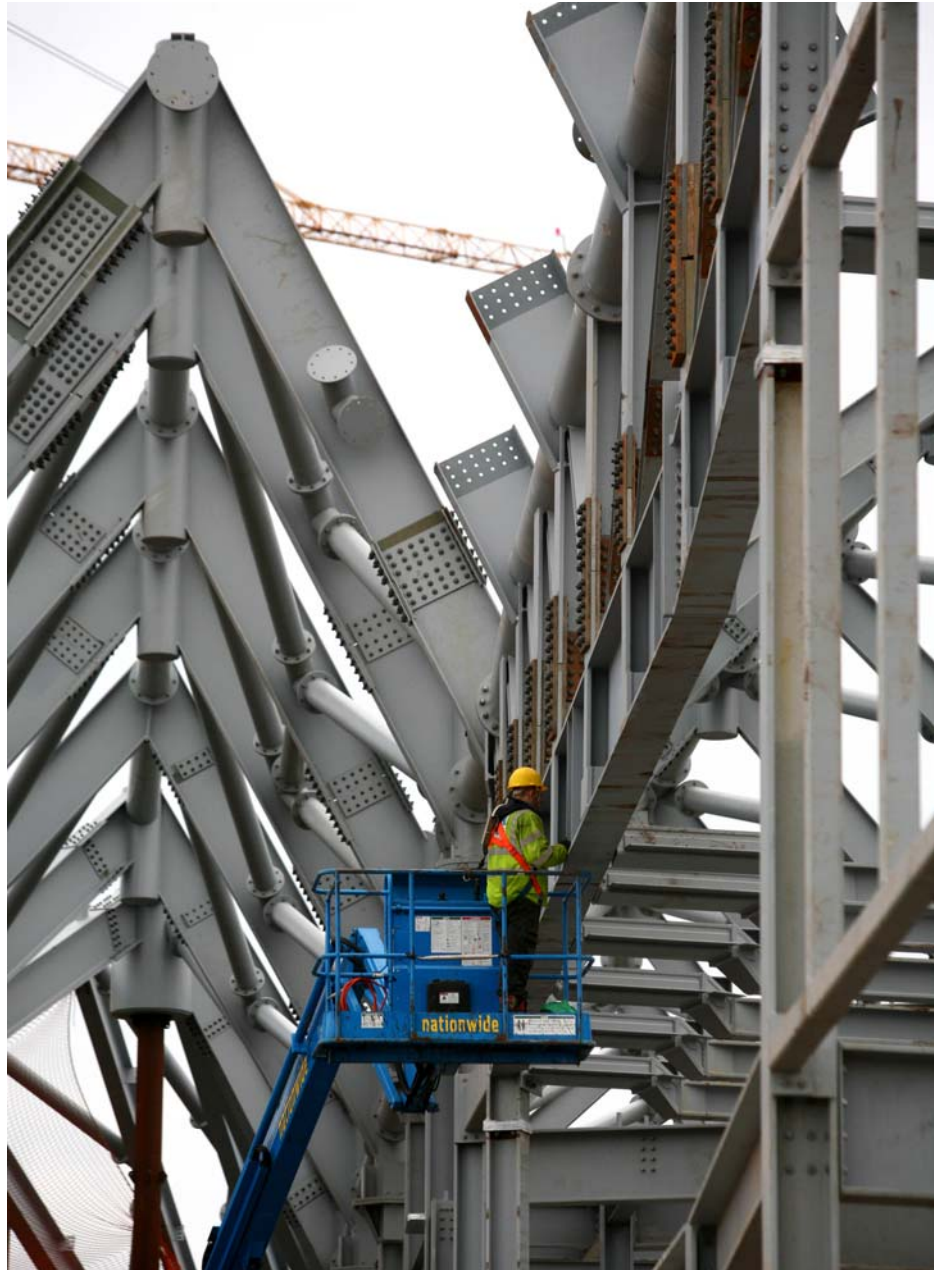

Figure 1.5 Roof steelwork for a transport museum

Structural steel frames generally rely on the use of hot rolled steel sections: for such sections, the material is heated and passed as a billet or blank through heavy rollers that gradually reduce and shape the cross-section whilst at the same time increasing the length; the final shape is generally in a standardised range. Typical cross section ranges are shown in Figure 1.6.

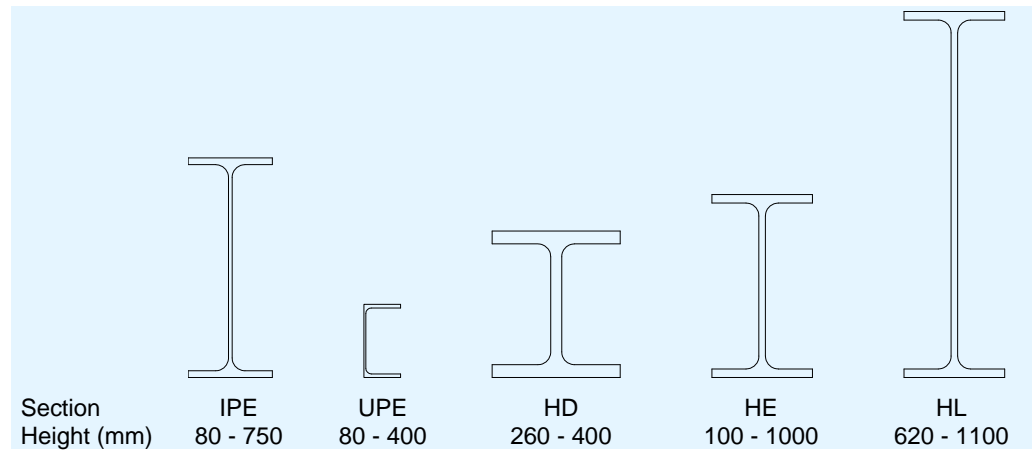

Figure 1.6 Typical hot rolled profiles

For larger spans, deep beams or other structural members can be fabricated from hot rolled sections and plate to form geometrically complex members. Hot rolled sections can be curved after manufacture, using bending equipment, or be converted to perforated web profiles using a variety of approaches, some of which split the beam into two in such a way that the two parts can be welded together as a deeper beam, with its spanning ability much increased.

Lighter steel sections can be formed by bending thin sheet steel into C or Z profiles. Normally this is done using either a cold rolling line (for standard sections) or by using a press or folding machine (for special sections). Common structural profiles range from around 80 mm to 350 mm deep, as shown in Figure 1.7, and are particularly suitable for roof purlins and side rails that support cladding, for lightweight frames, and as support to internal walls and partitions.

Wide thin sheets can be formed by cold rolling into profiled cladding for roofs and walls (see typical profiles in Figure 1.8) and into profiled floor decking.

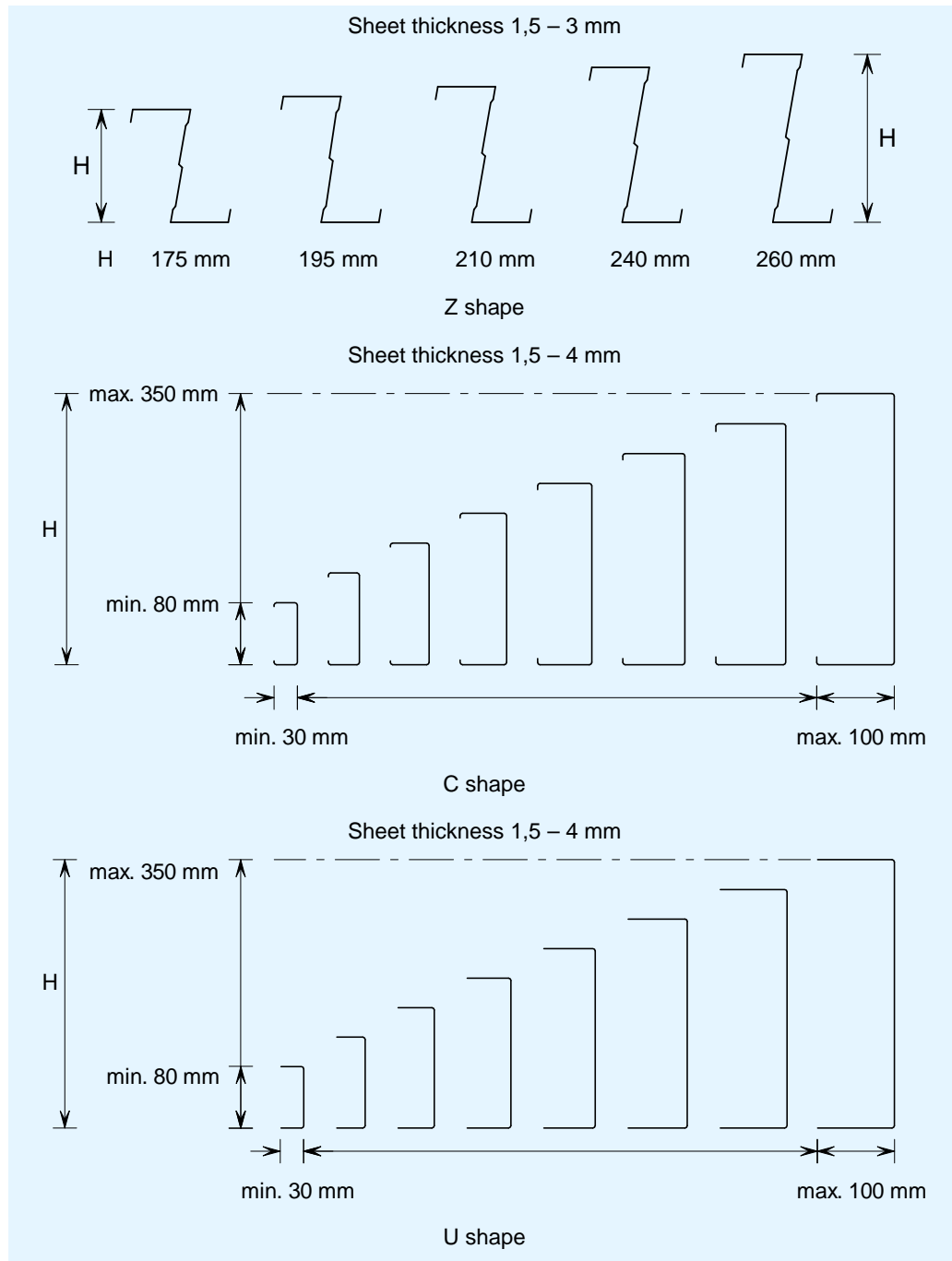

Figure 1.7 Typical cold-rolled section profiles

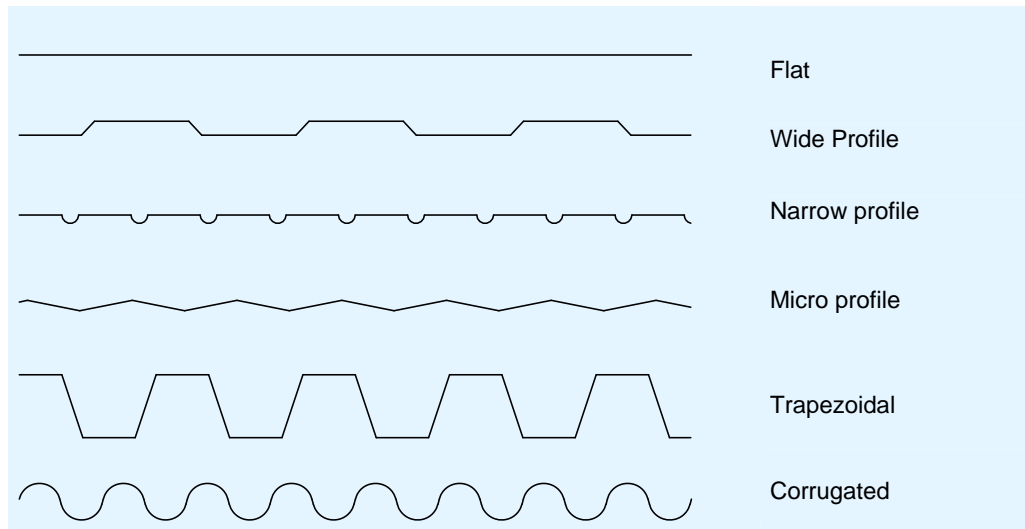

Figure 1.8 Typical cladding profiles

Steel members can be joined using a wide variety of techniques including welding and bolting; connection design is an important part of any structural system. Connection arrangements can be highly standardised or unique to suit a complex form. In expressed steelwork, connections often become important architectural elements in their own right.

1.2 Steel in single storey buildings

A steel building for commercial, industrial or agricultural use is typically a single storey, single span or multi-span building. Both building length and building width are much larger than the height of the building. Building functions include warehouses, distribution centres, retail outlets, exhibition spaces, sports halls and a wide range of commercial premises.

Each building type has its own specific requirements with regard to the internal space, though most require a space that is either entirely clear of structural members, or has internal columns reduced to a minimum. Usually, the structure is specifically designed for its purpose. For manufacturing and warehouse structures, economics and flexibility often have a greater influence than the appearance of the building. For other buildings, the appearance of the structure is more important and fabricated steelwork may be used to form architecturally appealing structures.

Buildings which are designed to be adaptable retain their value, as it is possible to divide, combine or extend them in the future. The re-usability of the building is a major factor when deciding between renovation and rebuilding.

Depending on the function of the building, the architect's brief will determine the basic layout of the structure. The structural engineer will have a wide choice of structural concepts, including simple frames, portal frames, trusses and arches. These solutions may range from the entirely functional for greatest economy to rather more adventurous architecture and external appeal.

2 ADVANTAGES OF CHOOSING A STEEL STRUCTURE

A very large proportion of all industrial and commercial single storey buildings utilise a steel structure, which demonstrates the cost-effectiveness of a steel solution. Architects and engineers use steel not only as an economical solution but also to achieve:

- low structural weight
- minimum construction dimensions
- a short construction time
- flexibility in use
- a sustainable solution

2.1 Low weight

A steel structure has a relatively low self-weight compared to masonry or concrete structures. This advantage not only reduces the foundations required for the structure, but also means that the structure is lightweight, reducing material delivery to the site. The off-site prefabrication of steel construction is a significant contribution to reduced transport of materials to site and reduced site activities, minimising construction disruption and environmental impact.



Figure 2.1 The relatively low self weight of steel structures reduces material delivery to site

2.2 Minimum construction dimensions

Steel enables large spans to be constructed with relatively small construction depths. The typical construction solution of an insulated external envelope supported on steel secondary members is a very well-developed solution, optimised over many years, leading to a structurally efficient and cost effective solution.

For pitched roofs or short span flat roofs, the construction depth of the roof beams or rafters can be as low as 1/40 of the span between columns. If internal columns are required for multi-span structures, they may be chosen to be small members, or the internal columns may be provided on every second (or every third) frame, maximising internal space and flexibility. Steelwork supporting the external envelope may be very slender, as shown in Figure 2.2, providing the opportunity for maximum natural lighting.



Figure 2.2 Slender construction takes up less space and results in transparent buildings.

2.3 Speed of construction

Structural steel components are pre-fabricated off site by a steelwork contractor; any protective coating that is required is applied at this stage. The site activity is primarily an assembly operation, bolting steelwork parts together, which leads to short construction periods. The building can be made weather tight quickly, allowing the following trades early access to commence their work.

Modern fabrication is achieved using numerically controlled machines, with data from three-dimensional electronic models of the complete structure. Modern fabrication is therefore extremely accurate, and errors that need rectification on site are rare. Three-dimensional building models can be used by other trades to ensure that their own contribution (for example, the cladding, or the mechanical and electrical services) can be properly co-ordinated with the structural frame before the building is constructed. All these facilities contribute to minimizing the period from conception to completion.



Figure 2.3 Prefabricated components are easily and rapidly connected on site

2.4 Flexibility and adaptability

A steel structure is both flexible and adaptable – design in steel is certainly not limited to rectangular grids and straight members, but can accommodate dramatic architectural intent, as shown in Figure 2.4.



Figure 2.4 Dramatic, expressed steelwork

Thanks to the numeric control of modern fabrication, components may be designed and fabricated to almost any shape desired. In most cases, a structure with an irregular floor plan or curved components is manufactured as easily as a rectilinear design, although there will be cost implications of the more complex fabrication.

The building can also be made adaptable for future changes in use. Column-free floor space facilitates future changes in internal layout, which is likely to happen several times in the life of a structure. The building structure can be modified, strengthened and extended. The facility to extend the structure at some future stage can be incorporated into the original design and construction details. The external envelope maybe renewed, upgraded or modified. Future owners/users with different requirements can readily adapt a steel building to their requirements.

2.5 A sustainable solution

Steel can be recycled any number of times without loss of quality or strength. Significant quantities of recycled steel are used in the manufacture of new steel products and there is a commercial value in scrap steel for this reason. Figure 2.5 shows scrap material being recycled to make new steel.

Steel building components are fabricated under controlled conditions with minimal waste (off-cuts are recycled as scrap). As the site activity is mainly assembly, there is rarely any waste on site.

Steel structures can often be disassembled, as they are primarily bolted skeletal structures. The steel members may reused in other structures – portal frames and similar structures are frequently dismantled and used at other locations.

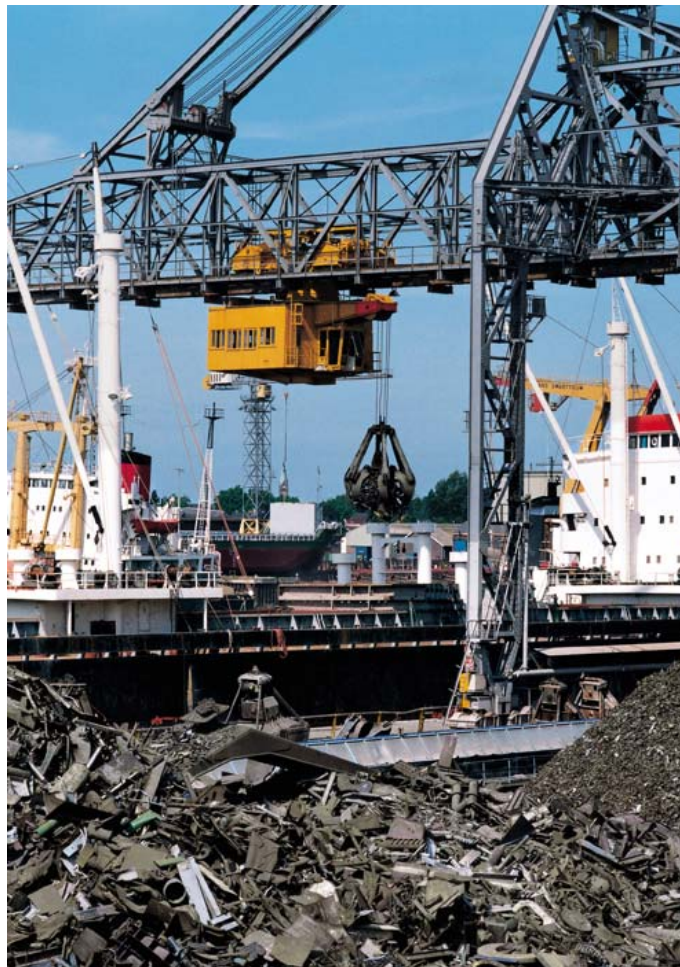

Figure 2.5 Modern steel making technology has the ability to recycle scrap

3 FORM OF PRIMARY STEEL STRUCTURE

Single storey steel buildings are generally built with an external cladding envelope, supported in many cases on relatively short span secondary steel members, which are in turn supported on the primary steel structure. This Section describes the structural possibilities that may be considered and comments on the type of structural sections that can be used.

3.1 Structure types

There are four basic structural configurations that provide a clear interior space for a single storey building:

- Rigid framed structures (portal frames and rigid-frame trusses)
- Pinned frame beam-and-column structures
- Cable-supported roofs
- Arched roofs

For the first three configurations, the designer has the option of providing either a flat roof or a pitched roof.

Typical spans and span/depth ratios for the primary roof members in pinned and rigid framed buildings are given in Table 3.1.

Table 3.1 Typical spans and structural depths for single storey structures

Structure type	Roof beam depth	Typical span range
Pinned frames		
Simple beam	span/30 to span/40	Up to approximately 20 m
Fabricated Beam	span/20 to span/25	Up to approximately 30 m
Perforated web beam	span/20 to span/60	Up to approximately 45 m
Truss roof (pitched)	span/5 to span/10	Up to approximately 20 m
Truss roof (flat)	span/15 to span/20	Up to approximately 100 m
Rigid frames		
Portal frame	span/60	15 m – 45 m
Truss roof (flat)	span/15 to span/20	Up to approximately 100 m

3.1.1 Rigid-framed structures

Rigid frames are achieved by providing a rigid (moment resisting) connection between the ends of the roof beams (or trusses) and the columns. The stiff frame that is created is much more efficient in carrying the imposed loads on the roof than a simply supported roof member (with nominally pinned connections at its ends) and the frame also provides resistance against wind forces on the sides of the building. Because the frames are self-supporting in the plane of the frame, the bracing in the roof can be reduced, compared to a structure with simply supported roof beams.

Rigid framed structures broadly fall into two categories, portal framed structures and truss framed structures.

Portal frames

Portal frames typically use hot-rolled I-section beams and columns for the roof rafters and supporting columns, although cold formed sections may be adequate for small span structures. Portal frames come in a variety of different shapes and sizes, with flat and pitched roofs.

A typical configuration is shown in Figure 3.1. The roof and wall cladding is supported on purlins and side rails that span between the portal frames. Bracing is not needed between every frame but is needed in at least one bay to transfer longitudinal forces (normal to the frames) to the side walls and thus to ground level.

In some special design situations, the cladding can be used as the bracing – this is known as stressed skin design. The design of the cladding and the fixings to the supporting members will be assessed by the structural engineer. In most cases, bracing will be provided that does not rely on the sheeting.

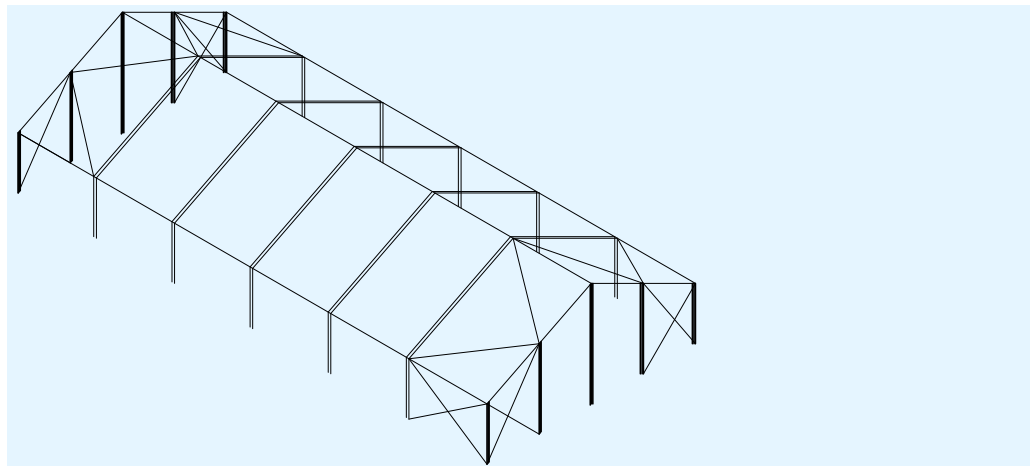

Figure 3.1 Typical structural configuration of a portal frame structure

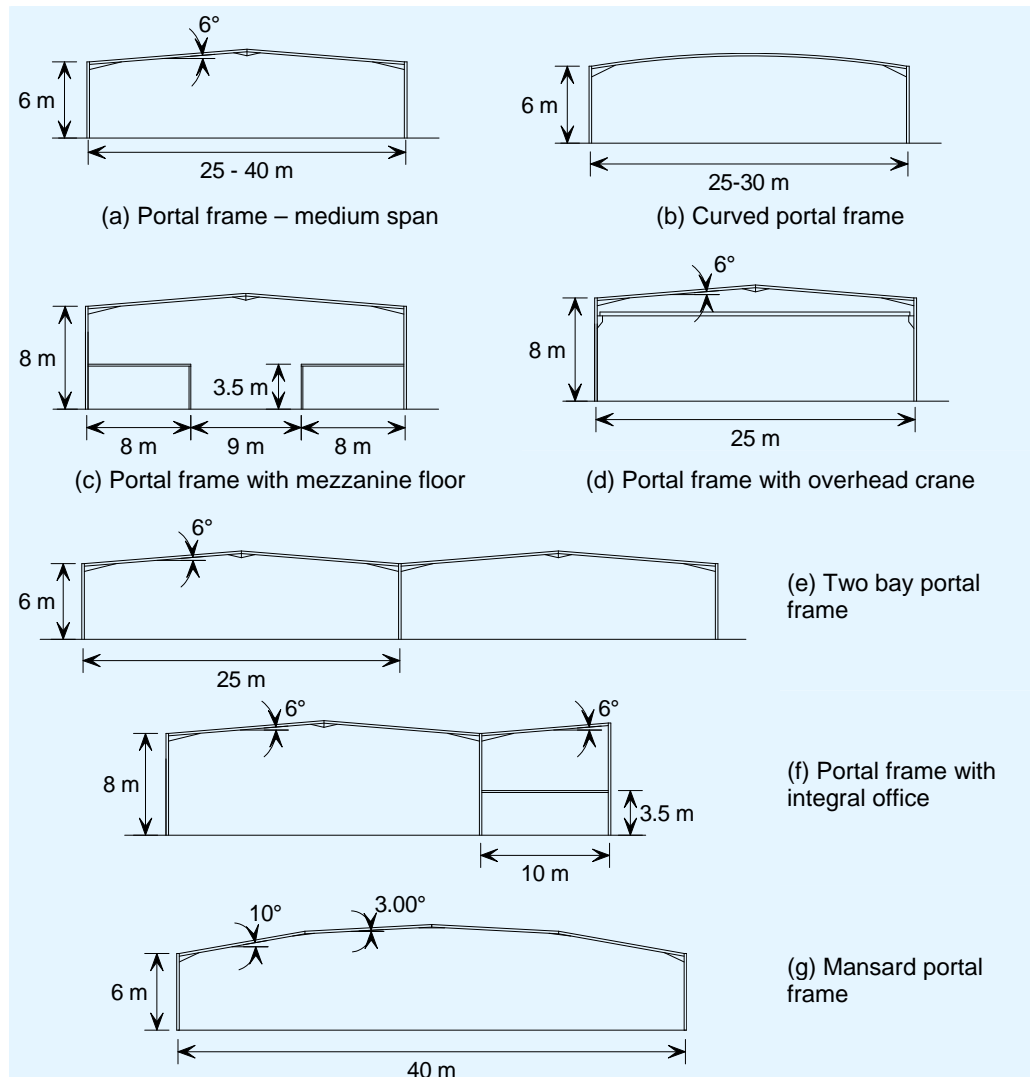

Figure 3.2 Forms of portal frame

Portal frames typically have straight rafters, as shown in Figure 3.3. The same structural principles can be followed to form a portal frame with a curved rafter, as shown in Figure 3.4. In each case, the connection of the rafter to the column is substantial, and usually the rafter is haunched locally to the column. The dimensions of the haunch should be allowed for when considering the clear height requirements.



Figure 3.3 Pitched roof portal frame



Figure 3.4 Curved roof portal frame

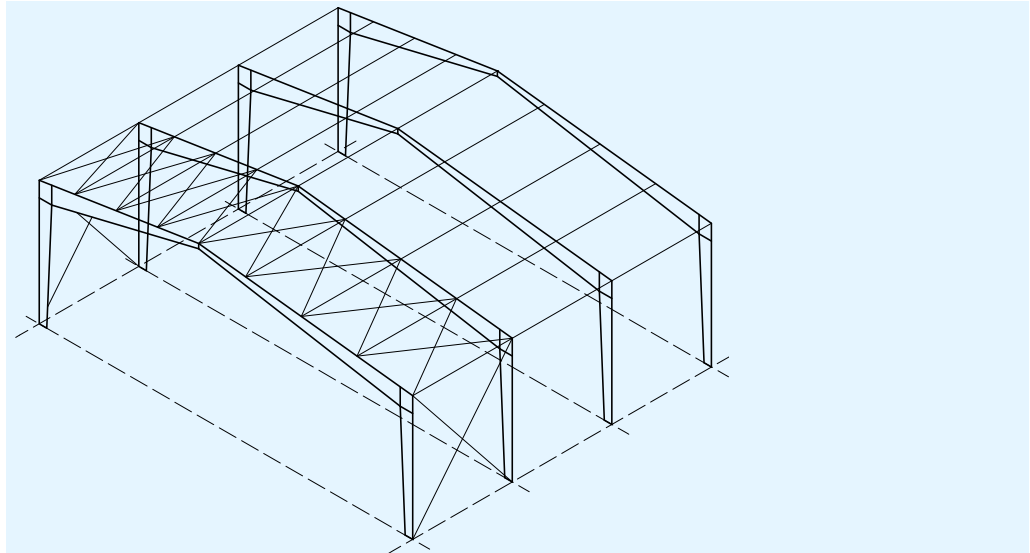

Figure 3.5 Typical roof and wall bracing in portal framed structures

In most cases, the rafter (and possibly the column) will need local restraints, as shown on Figure 3.6. In some countries, special provision must be made when using this form of restraint, to ensure that the purlins align with the roof bracing system. The location of these restraints will be specified by the structural engineer.



Figure 3.6 Stabilizing the bottom flange of a roof beam

Rigid framed trusses

When flat trusses are used, both top and bottom chords can easily be connected to the supporting columns, thus creating a rigid frame. For larger spans, roof trusses provide an effective and economic alternative. Typical flat truss shapes are shown in Figure 3.7, and a truss roof is illustrated in Figure 3.8.

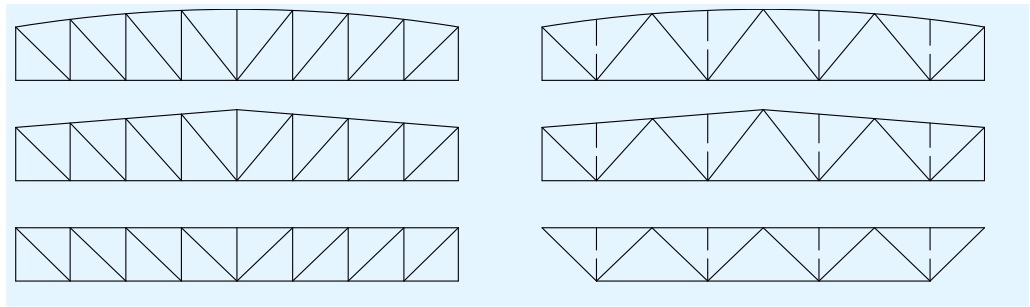

Figure 3.7 Typical truss shapes



Figure 3.8 Rigid frame flat truss (N-type)

In some situations, the columns are also of lattice form and then the building configuration is typically as shown in Figure 3.9.

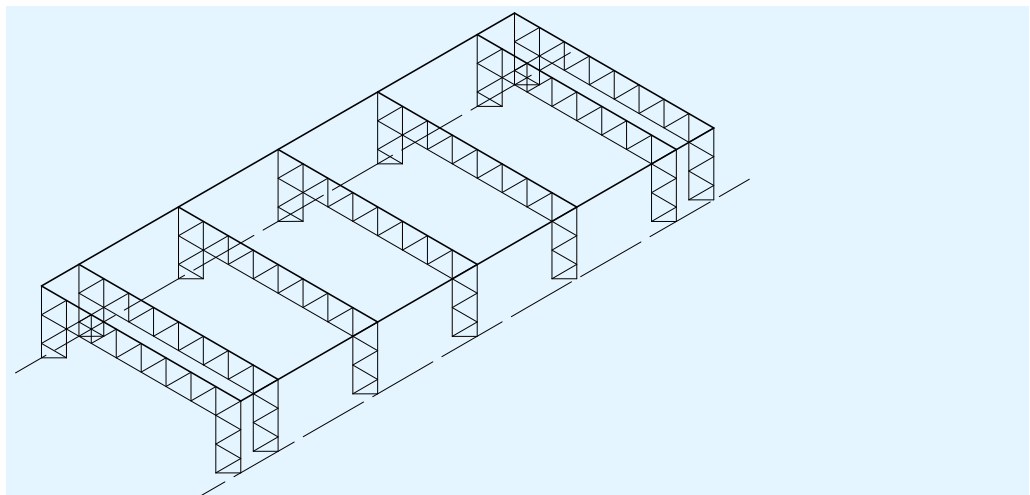

Figure 3.9 Rigid frame flat truss with lattice columns

The lateral stability of the top chords of trusses is usually provided by the purlins (and by one panel of bracing, as for portal frames) but where stressed skin design is permitted, it may provide the restraint without bracing, as shown in Figure 3.10.

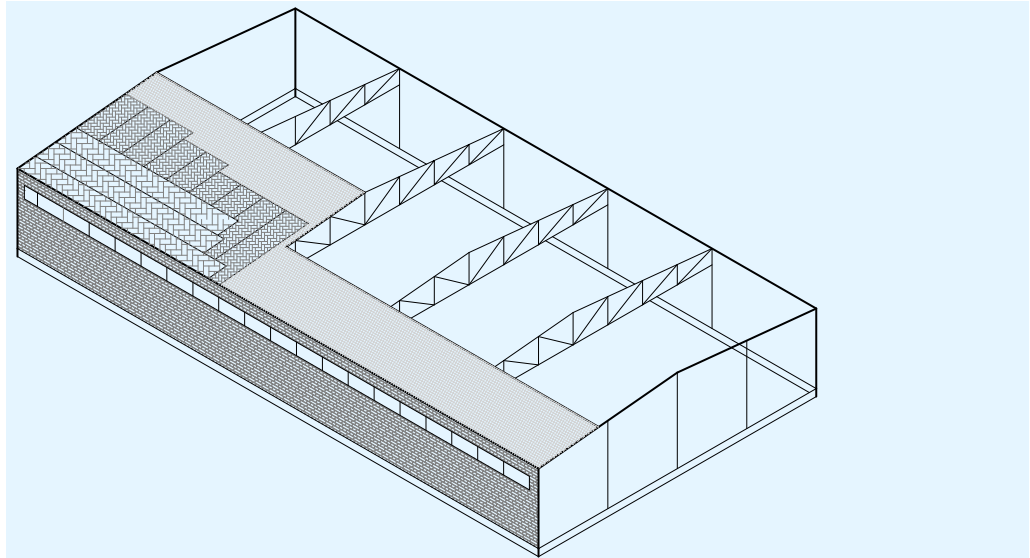

Figure 3.10 Roof cladding acting as stressed skin in a rigid-framed truss roof

3.1.2 Pinned frame beam and column structures

In a pinned frame beam and column structure, the basic configuration is a series of parallel beams, each supported by columns at its ends, with a pinned or flexible connection between the beam and the column. Bracing has to be provided in the roof to transfer horizontal forces due to wind loads to the end and side walls; the walls are braced to transfer the forces to the foundations. (Alternatively, some countries allow the roof cladding to act as a 'stressed skin', thus largely eliminating the need for separate bracing.) A typical structural configuration is shown in Figure 3.11.

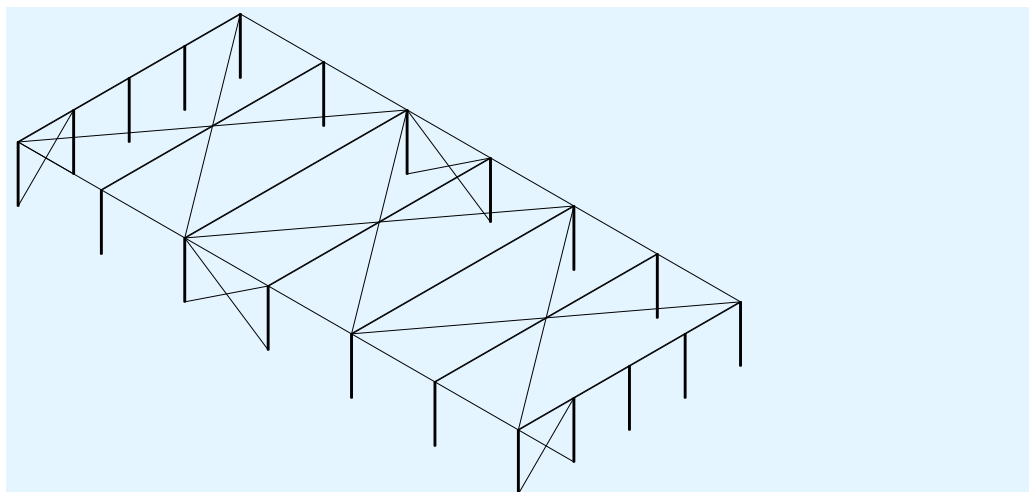

Figure 3.11 Typical structural configuration for a beam and column structure

There are numerous options for the beams:

- Hot rolled sections (I-beams)
- Plate girders
- Fabricated beams with holes in the webs
- Trusses

Hot rolled I section beams

The most common type of beam and column structure uses hot rolled steel I sections for both beams and columns. These sections are produced in accordance with international standards and there are design tables available to allow for an easy selection of section size to suit the loading. The most common section sizes are readily available from stockists and can be ordered at short notice.

Deep sections with relatively narrow flanges are preferred for roof beams, as shown in Figure 3.12, where they primarily resist bending. Columns, which primarily resist compression, are usually thicker, shallower sections with wider flanges.

The span/depth ratio for the roof beams is typically 30 to 40 for spans up to 20 m.



Figure 3.12 Pinned frame beam and column structure

Plate girders

Plate girders are built up beams consisting of two flange plates, welded to a web plate to form an I-section. This type of beam offers a solution when the standard I and H beams are not suitable. The section dimensions are chosen to suit the design bending moments and shear forces; the beams can be profiled in elevation, as shown in Figure 3.13.

The span/depth ratio is typically 20 to 25 for spans up to 30 m.

An alternative that is sometimes used for large spans, to reduce the thickness of the web plate, is the use of a corrugated plate (profiled in plan). The span/depth ratio with a profiled web plate is typically 30 to 40 for spans up to 100 m.

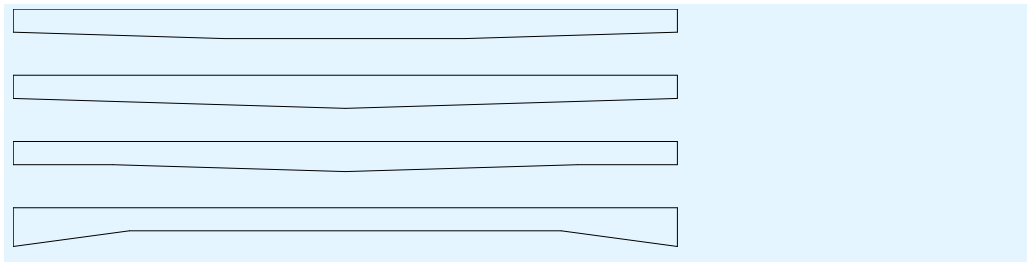

Figure 3.13 Tapered plate girders

Plate girders are likely to be more expensive than hot-rolled standard sections.

Beams with web openings

Because roof beams generally carry relatively light uniformly distributed loads, beam sections that span large distances can be created by fabricating sections with openings in the webs. Historically, the first beam of this type was the castellated beam, with hexagonal holes. Now beams with circular openings are commonly used.

In both cases, the beam is fabricated from a rolled I section by cutting along the web, to a special profile, separating the two halves and then displacing one half relative to the other and welding them back together. This is illustrated in Figure 3.14. The major advantage of this type of beam is the weight reduction: approximately 30% less than a beam with a solid web of similar depth and bending resistance.

An example of the use of beams with circular openings is shown in Figure 3.15.

Beams with web openings are less suitable for heavy concentrated loads.

The span/depth ratio is typically 30 for spans up to 50 m.

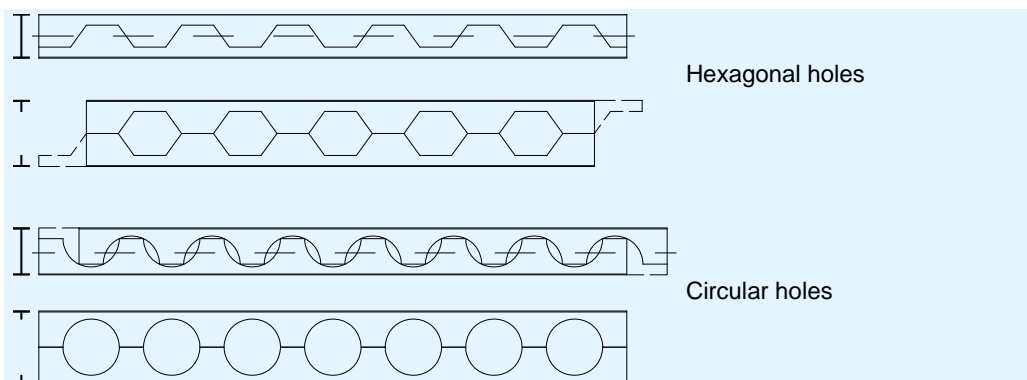

Figure 3.14 Fabrication of beams with web openings



Figure 3.15 Beams with circular web openings

Trusses

Trusses are a triangulated assembly of members. Two basic configurations are used in single storey buildings – pitched roof trusses and ‘flat’ trusses of near uniform depth.

Pitched roof trusses

A variety of pitched roof truss forms are used in pinned frames, as illustrated in Figure 3.16.

The trusses illustrated in Figure 3.16 are commonly fabricated from T and angle sections, and are used to create a sloped roof. The large (mostly unused) space between the trusses may be considered a disadvantage, requiring heating and raising the overall height of the structure, but it is a cost effective solution for modest spans and provides space for services.

Because these trusses are used with a steeply sloping roof, the span/depth ratio is typically 5 to 10 for spans up to 20 m

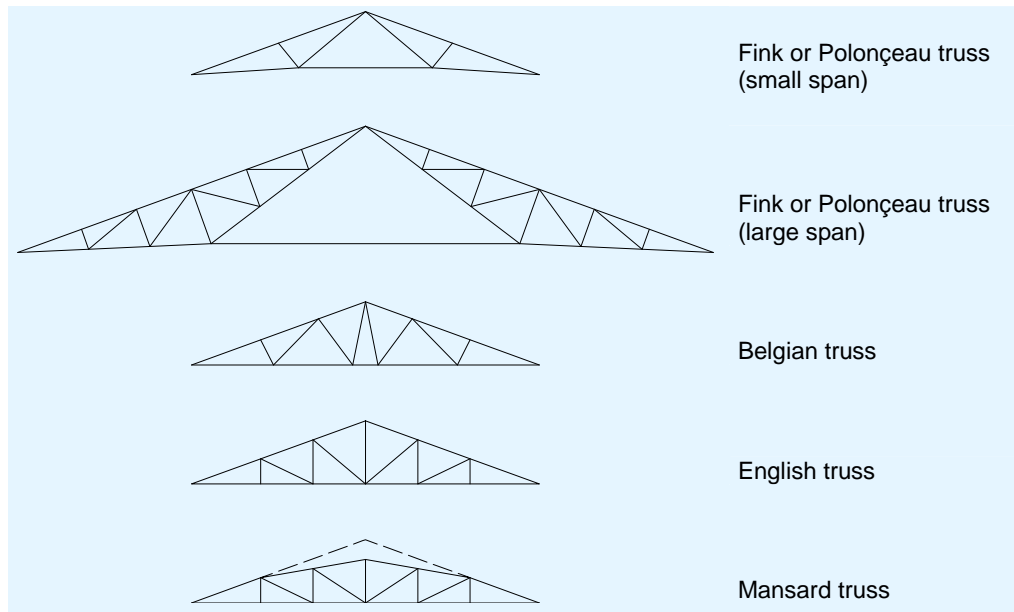

Figure 3.16 Types of pitched roof truss

Flat trusses

Flat trusses are used mainly in rigid frames (see Section 0 for a more comprehensive description) but they are also employed in pinned frames – an example is shown in Figure 3.17.



Figure 3.17 Flat truss in pinned frame building

Trusses typically have a greater depth than single beams or plate girders. The deflection of a truss is modest, and can be controlled, making trusses especially suitable when significant loads have to be supported from the roof structure, or when a flat (or nearly flat) roof is to be provided. The larger depth of the trusses increases the dimensions of the façade, but also provides space for services to be placed in the roof structure instead of below.

The weight of a trussed roof structure per unit area of roof in general is less than that of single beam girders, but the fabrication costs are higher. Trusses

may be exposed in the completed structure, which may increase the fabrication costs if, for example, hollow sections are used for the members.

The span/depth ratio for flat trusses is typically 15 to 20 for spans up to 100 m.

Trusses are usually planar and will generally require bracing of some form to provide stability. As an alternative, three-dimensional trusses can be created, as shown in cross section in Figure 3.18 and illustrated in Figure 3.19. This form of truss is generally expensive to fabricate, because of the complex intersections of the internal members.

The span/depth ratio for three-dimensional trusses is typically 16 to 20 for spans over 50 m.

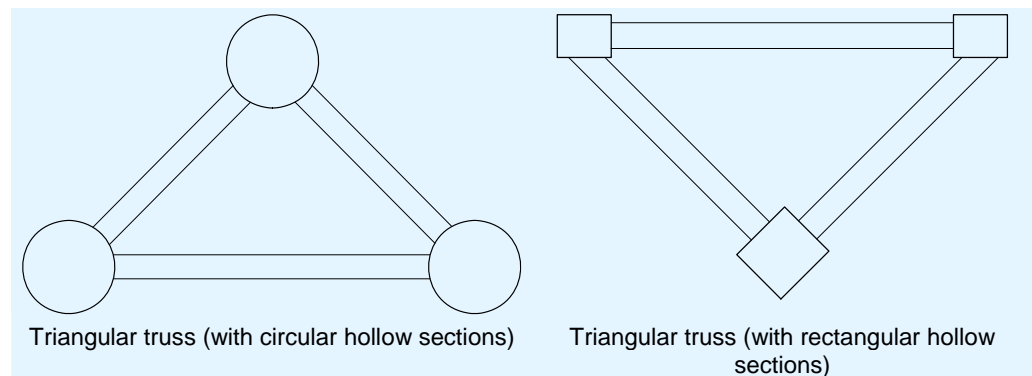

Figure 3.18 Three dimensional triangular trusses



Figure 3.19 Three-dimensional trusses supporting a roof

3.1.3 Cable stayed roofs

In a cable-stayed structure, tensile members (wire ropes or bars) are provided to give intermediate support to members such as roof beams, thus allowing those members to be reduced in size. The stays need to be supported by columns or masts and those members need to be anchored or braced with other stays. The bracing arrangement is usually very conspicuous and the aesthetics

of the building must be considered carefully. An example of a cable stayed building structure is shown in Figure 3.20.



Figure 3.20 Cable stayed roof beams of a storage facility

Alternative configurations for a flat roof building are shown in Figure 3.21.

Cable stayed configurations are most economical for spans between 30 m and 90 m.

As most of the structure is outside of the building, maintenance costs can be high. Care must be taken in detailing the waterproofing where the stays pass through the cladding.

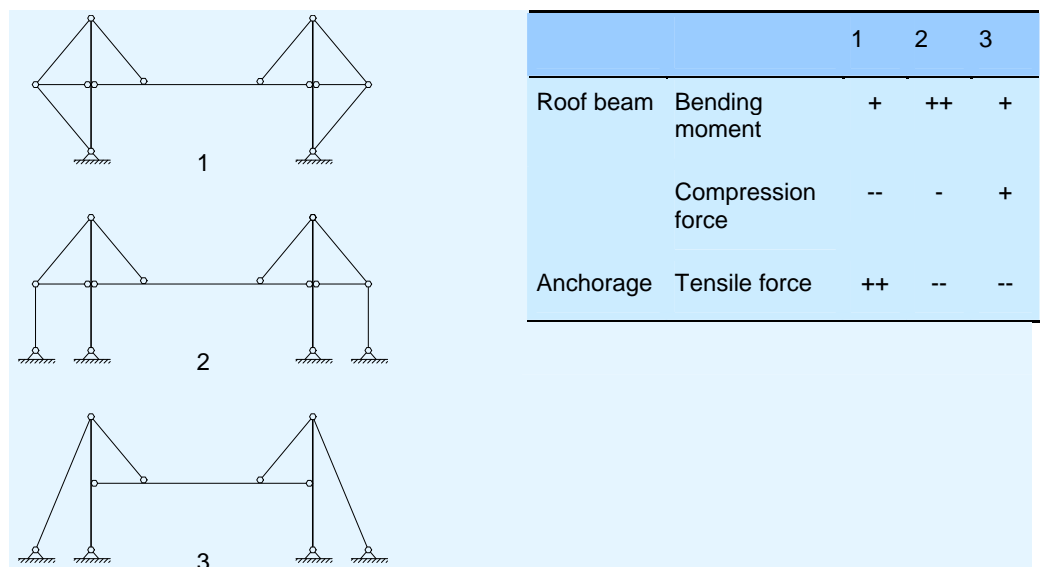

Figure 3.21 Comparison of the three main configurations for cable stayed structures

The arrangement of the structure has a significant effect on the internal forces and therefore the member sizes. The building arrangement should be developed in collaboration with the structural engineer.

3.1.4 Arches

Arches have a parabolic or circular form, as illustrated in Figure 3.22. Uniform loading is carried by compression in the arch members; modest bending moments are induced by non-uniform loading and point loads. The compression forces must be resisted by horizontal forces in the foundation of the building – or by tie members between the foundations, as shown in Figure 3.22.

Arch members can be formed by cold bending I-section beams.

The span/depth ratio for the arch members is typically between 60 and 75 for spans up to 50 m.

An example of an arched roof building is shown in Figure 3.23.

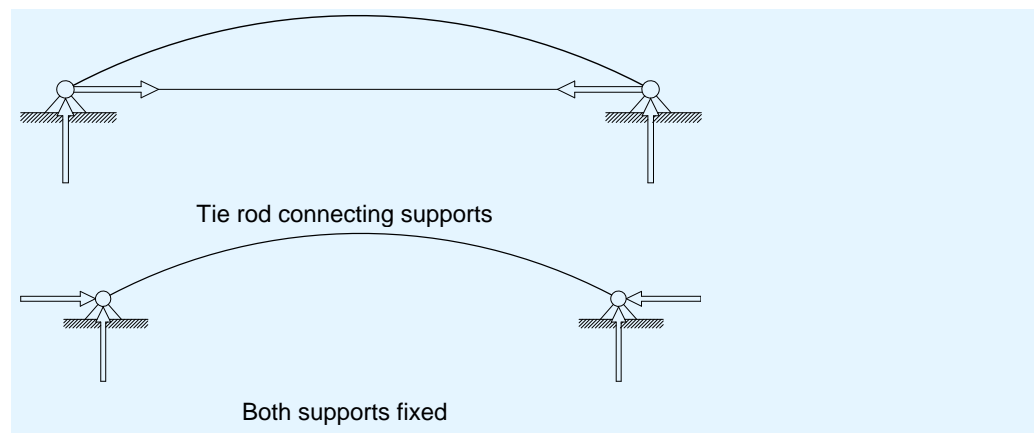

Figure 3.22 Methods of supporting arch members



Figure 3.23 Fire brigade station

3.2 Connections between columns and beams

3.2.1 Moment-resisting connections

In a portal frame structure, the connections between beams and columns transfer bending moments, as well as shear and axial forces, and they must be designed as rigid connections.

A rigid connection typically has a full depth end plate. The roof beam is often haunched locally and the column web is stiffened in order to resist the local forces from the end of the roof beam. In general, stiffeners should be avoided if possible, as they add significant fabrication cost.

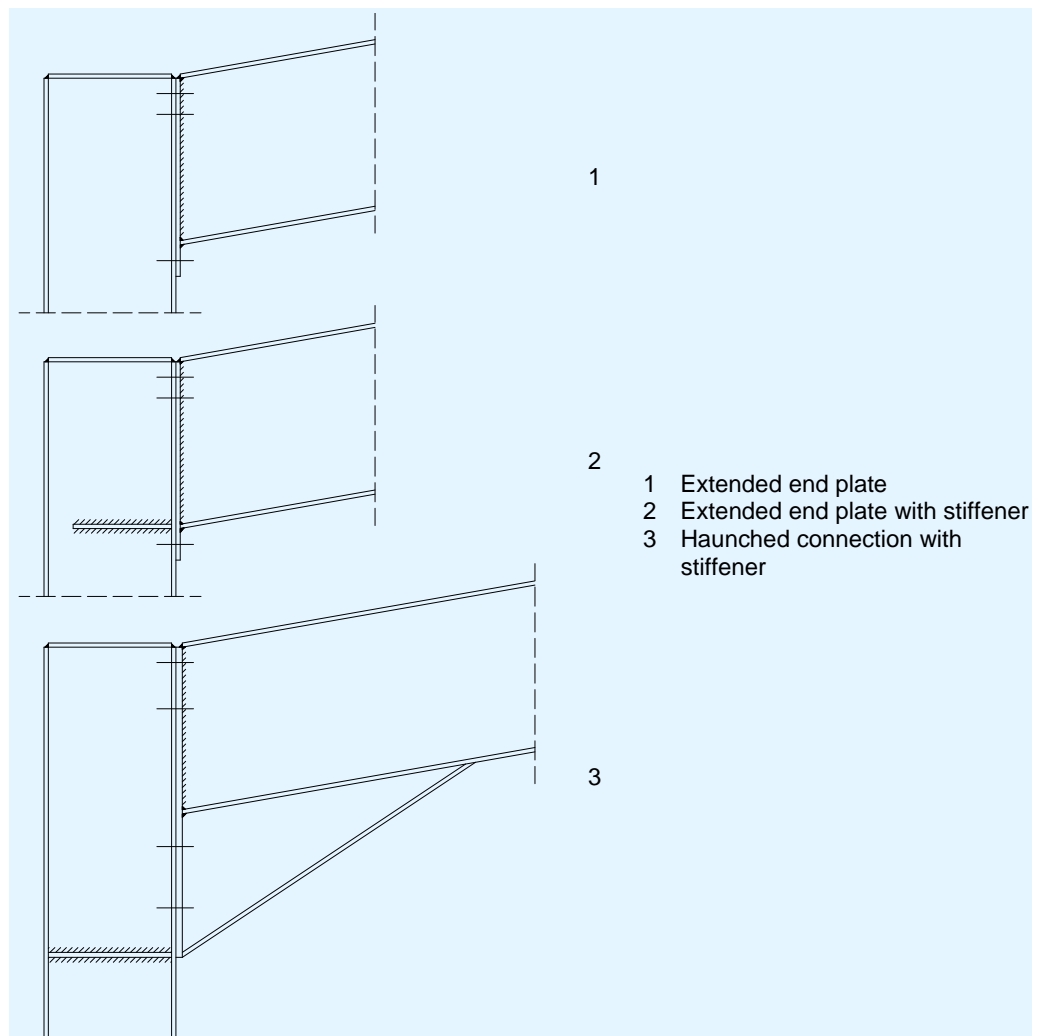

Figure 3.24 Rigid bolted connections between roof beams and columns

Connections between trusses and columns are usually achieved by end plates on the top and bottom chords, bolted to the face of the column. A typical example is illustrated in Figure 3.25.



Figure 3.25 Truss-column connection in a rigid framed structure

3.2.2 Nominally pinned connections

In a beam and column structure, the connections are nominally pinned and are not assumed to transfer any moments between the connected members. Externally applied actions, such as wind forces, must be resisted by bracing systems. The bracing system may be steel bracing, or a stiff core. For single storey structures, a system of steel bracing is almost universally adopted.

Pinned connections are relatively easy (and cheap) to fabricate. Typical connections use partial depth end plates, fin plates or angle cleats; the members are bolted together on site.

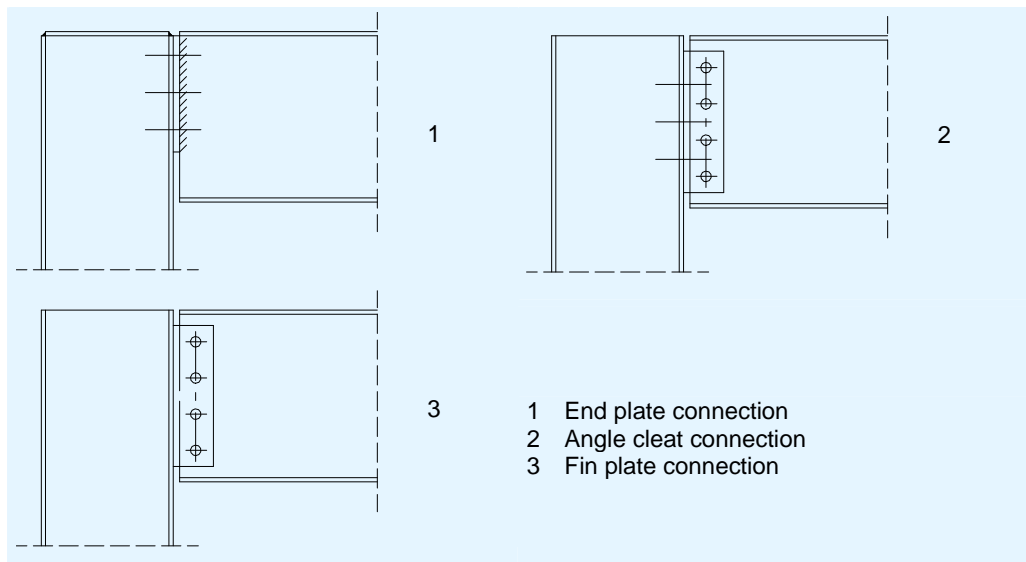

Figure 3.26 Nominally pinned bolted connections

4 BUILDING ENVELOPE

The steel structure of a single storey building generally comprises three principal components: a primary construction (roof beams and columns, with bracing); secondary steelwork, such as purlins and side rails that support the roof panels and wall cladding; and the roof panels and cladding themselves. The roof panels and cladding are generally referred to as the building envelope.

The building envelope provides a weather-tight enclosure to the building space. In most cases, it also provides thermal insulation from the exterior environment. The exterior appearance is often a major consideration in the choice of the form of the envelope. The architect must therefore choose a system that balances the demands of sustaining actions such as wind pressure and (on flat or near-flat-roofs) imposed loads, of achieving thermal performance that meets criteria for low energy use, and of producing an appearance that meets the client's aspirations.

A single type of cladding system is often used for both roof and walls.

Detailing will be an important element of envelope design. Drainage systems that do not block or leak are essential and the integration of openings (windows and doors) with the cladding must not compromise thermal insulation.

A striking example of using coloured profiled sheeting is shown in Figure 4.1.



Figure 4.1 Car repair workshop with steel roof and façade

4.1 Cladding systems

The principal options for cladding systems are:

- Profiled steel sheeting
 - Single-skin
 - Double-skin, built up on site from a liner panel, insulation and an outer sheet
 - Composite sandwich panels, pre-fabricated off site from an inner sheet, and outer sheet and insulation.
- Steel sheeting with insulation, covered by a waterproof membrane – commonly used on flat roofs.
- Wooden panels/decking
- Precast concrete slabs
- Blockwork (for walls)

4.1.1 Profiled sheet cladding

The basic types of profiled steel sheeting system, used in roofs and walls, are summarized in Table 4.1.

Table 4.1 Basic types of cladding system

System	Insulated?	Benefits
Built up systems	yes	<ul style="list-style-type: none"> • free choice for exterior profiled sheeting • high fire resistance • good sound proofing and good sound absorption • fast construction, with simple mechanical fasteners
Composite panels	yes	<ul style="list-style-type: none"> • fast construction • fully prefabricated
single sheeting	no	<ul style="list-style-type: none"> • cheap and fast construction • easy to dismantle • large freedom of form

4.1.2 Precast concrete slabs

For flat roofs with significant imposed loads, cellular concrete slabs provide both a relatively easily installed building component and a thermal insulation layer.

Precast concrete slabs (either hollow core or sandwich panel) provide the necessary strength where there are heavy snow loads or a heavy roof is required for safety reasons (e.g. resisting explosive pressures in accidental situations). However, precast slabs are much heavier than profiled steel cladding and the primary steel structure must be correspondingly stronger.

4.1.3 Blockwork

Blockwork construction is often used for the walls of single storey buildings, either full height or partial height (with sheet cladding for the top of the wall). The blockwork provides insulation and robustness; it may also be chosen for appearance.

4.2 Secondary steelwork

Secondary beams are used when the spacing of the main beams or trusses is too large for the cladding or roof panels to span between them, or where the cladding spans parallel to the main beams, which is usually the case with pitched roofs.

For these secondary members, there is a choice between cold-formed and hot-rolled steel sections. The profiles of typical cold formed sections are shown in Figure 4.2. A cold formed section can be up to 30% lighter than a hot rolled section.

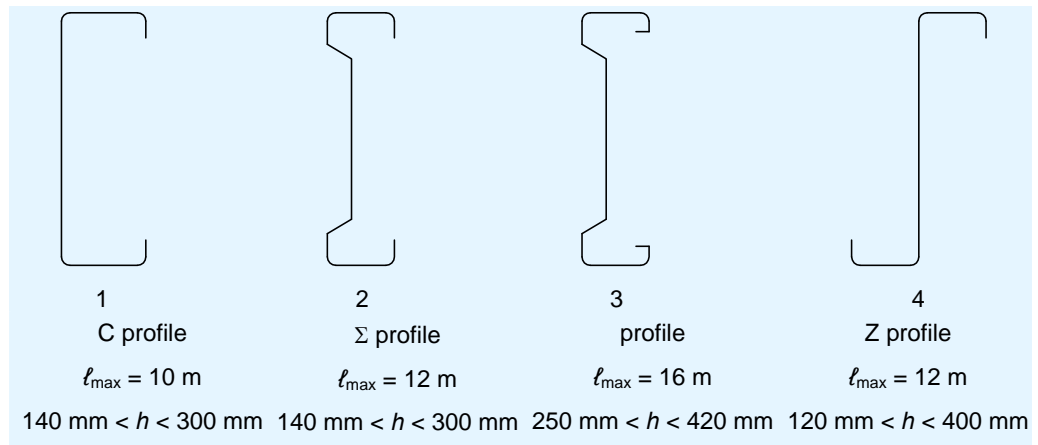

Figure 4.2 Typical cross sections of cold formed beams

Cold formed sections are manufactured from galvanized steel and this normally provides sufficient protection against corrosion in the internal environment of the building (an exception might be, for example, in aggressive environments such as cattle sheds, where ammonia is present).

Secondary members of cold-formed sections are used at relatively low spacing, typically between 1,6 m and 2,5 m. Very long secondary members can be fabricated as small trusses.

4.3 Roofs

The choice between a flat roof and a pitched roof often depends on the particular preferences in the local or national region. Some countries favour flat roofs that are able to sustain significant imposed loading, other countries favour pitched roofs that facilitate drainage and which are subject to only very modest imposed loading. Clearly, the type of cladding that is appropriate depends on those choices and circumstances.

4.3.1 Pitched roofs

The slope of a pitched roof also depends on local circumstances and custom. A slope of at least 10% (6°) is normally provided.

Where profiled sheeting is used, the profiles run down the slope, to facilitate drainage. Insulation must therefore be below the outer sheeting (possibly as a composite panel). The sheeting is supported on purlins spanning between the

roof beams and is fastened with screws or bolts. The lapped sheets do not require a waterproof membrane; the panels are simply lapped, the higher above the lower on the slope.

A typical arrangement of a pitched roof at the eaves is shown in Figure 4.3. It is important that the drainage system is adequate for the run-off from the whole roof.

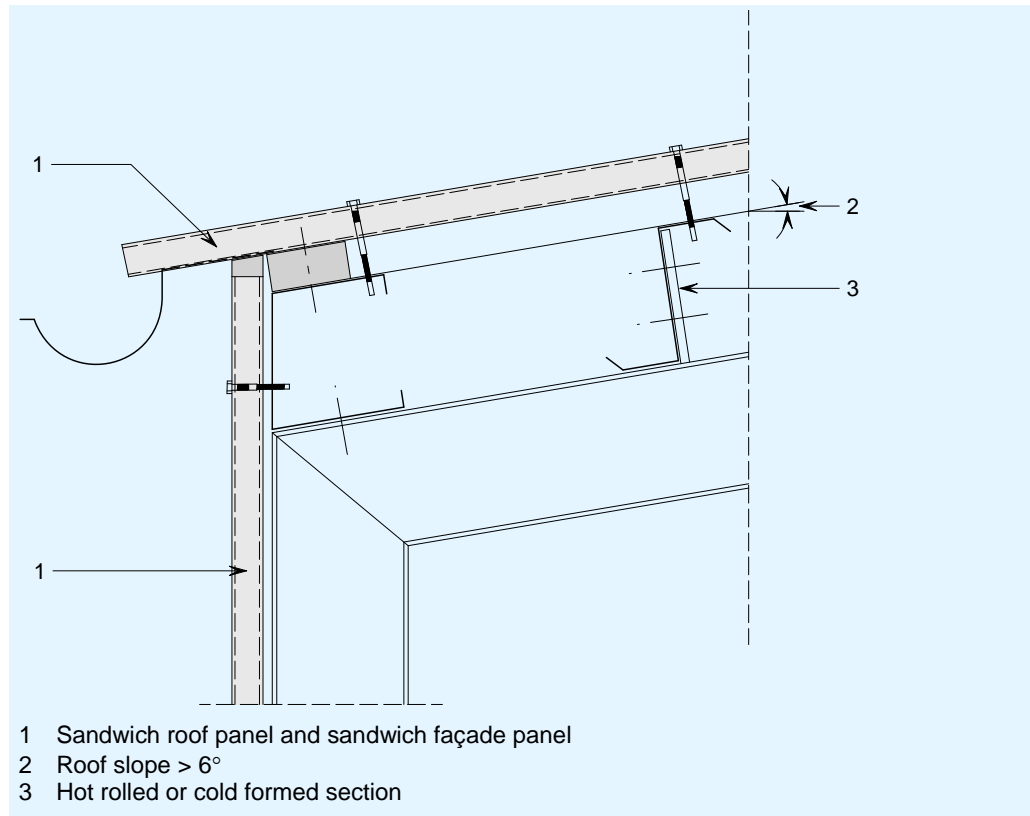

Figure 4.3 Insulated sloped roof

4.3.2 Flat roofs

Where the roof is flat, it must be fully watertight against standing water and it is therefore usual to apply a waterproofing membrane on its top surface.

Where profiled steel sheeting is used, it is typically a deep profile, spanning between the primary structural members. Insulation is then placed on top of the sheeting, fixed with bolts or screws. The waterproof membrane is then applied on top of the insulation. An example is shown in Figure 4.4.

Where flat roofs are provided, there is a risk of ponding. Water can accumulate in the central area if the roof deflects significantly. If there is inadequate drainage, water can also be retained by kerbs or other details around the edge of the roof. It is vitally important to minimise the risk of ponding by precambering the roof and providing adequate drainage.

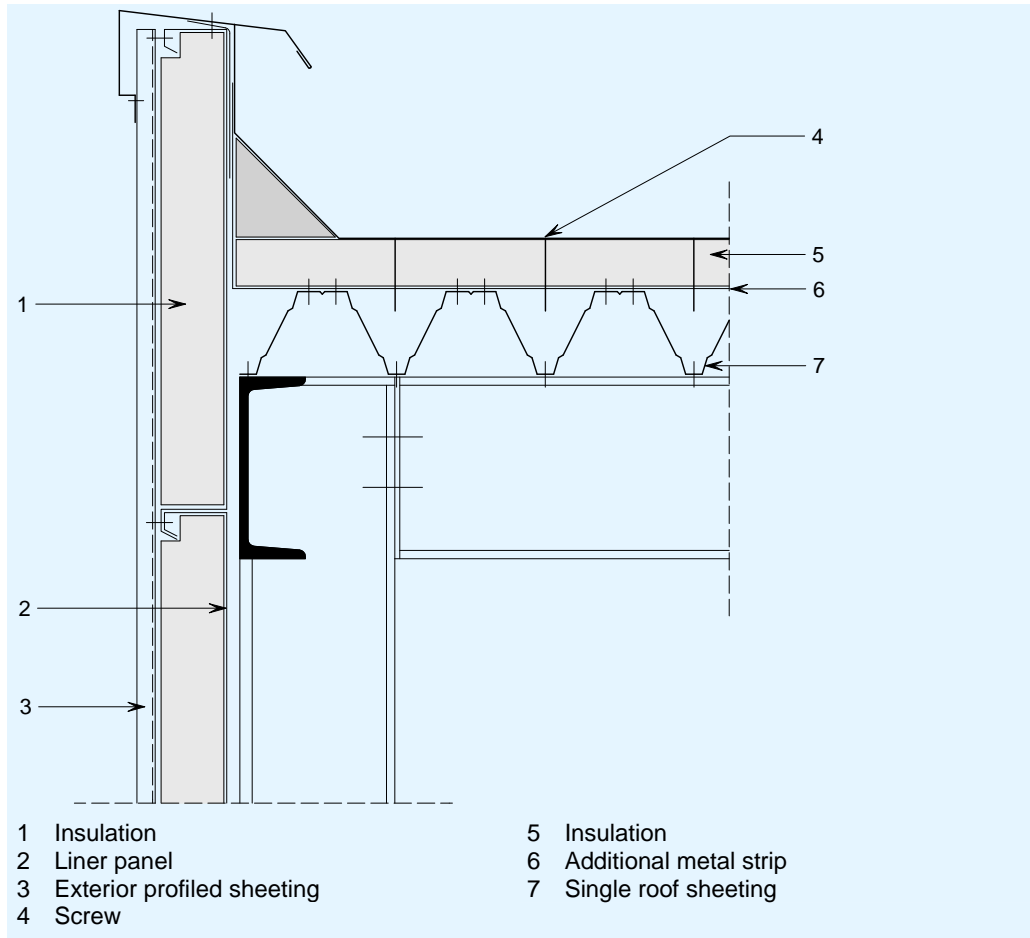

Figure 4.4 Insulated flat roof

5 FIRE SAFETY

Requirements for fire safety are defined by national regulations but there are recognised international rules for assessing the fire resistance of steel structures. The minimum level of safety for structural fire design aims to provide an acceptable risk associated with the safety of building occupants, fire fighters and people in the proximity of the building. Levels of safety can be increased to protect the building contents, the building superstructure, heritage, business continuity, corporate image of the occupants or owner, and the environmental impact.

Requirements are usually expressed in relation to:

- **Spread of fire:** combustibility of the materials expressed in relation to time until flashover. It is classified as A1 (flashover not possible) down to E (flashover in less than 2 minutes) and F (not tested).
- **Smoke intensity:** materials are classified from class A2 to F depending on the smoke produced on combustion.
- **Fire resistance:** the period of time for which a structural component can perform in a standardized fire test. The three criteria of load-bearing capacity, integrity and insulation (commonly expressed as R, E and I) are considered and the rating is expressed as R30, R60 etc. where the number refers to the period in minutes.

In order to achieve the required fire safety level in a single storey building the following items should be taken in account:

- regulatory requirements
- fire partitioning
- fire spreading
- escape routes

Single storey buildings often have very modest requirements for fire resistance because occupants can escape quickly. The main requirement is often the prevention of fire spread to adjacent properties.

To protect contents, especially in large production facilities and warehouses, partitioning may be needed or, where that is not feasible, alternative measures may be taken, such as the installation of a sprinkler system.

6 OVERHEAD CRANES

Certain industrial buildings require overhead cranes – examples are printing shops (for moving rolls of paper) and engineering shops (for moving heavy equipment and components). An example is shown in Figure 6.1.

Most overhead cranes use single or twin beams spanning across the building and with a hoist mounted on the beams. The crane beams are supported on runway beams that run the length of the building. The crane serves the whole floor by moving along the runway beams and by moving the hoist along the crane beams (Figure 6.2).

Incorporating an overhead crane in a building always influences the design of the building structure, even when the hoisting capacity is very modest. A key design consideration is to limit the spread of the columns at the level of the crane. For this reason, portal frames are not appropriate for heavy cranes as limiting the column movement becomes uneconomic. Crane use also results in horizontal forces from movement of the loads, so additional bracing is usually provided.

A crane with a lifting capacity up to a safe working load of about 10 tons (100 kN) can usually be carried on runway beams that are supported off the columns that support the roof. For larger cranes, it is more economical to use separate columns (or vertical trusses) to support the runway beams and avoid excessive loads on the building structure.

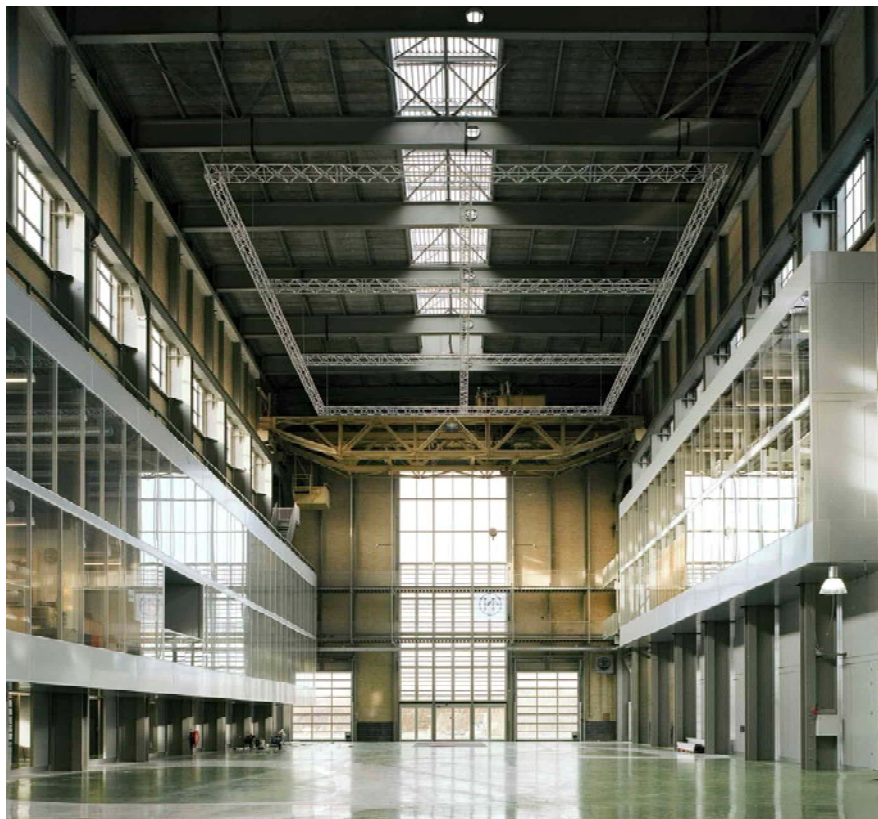

Figure 6.1 Heavy crane in a large industrial building

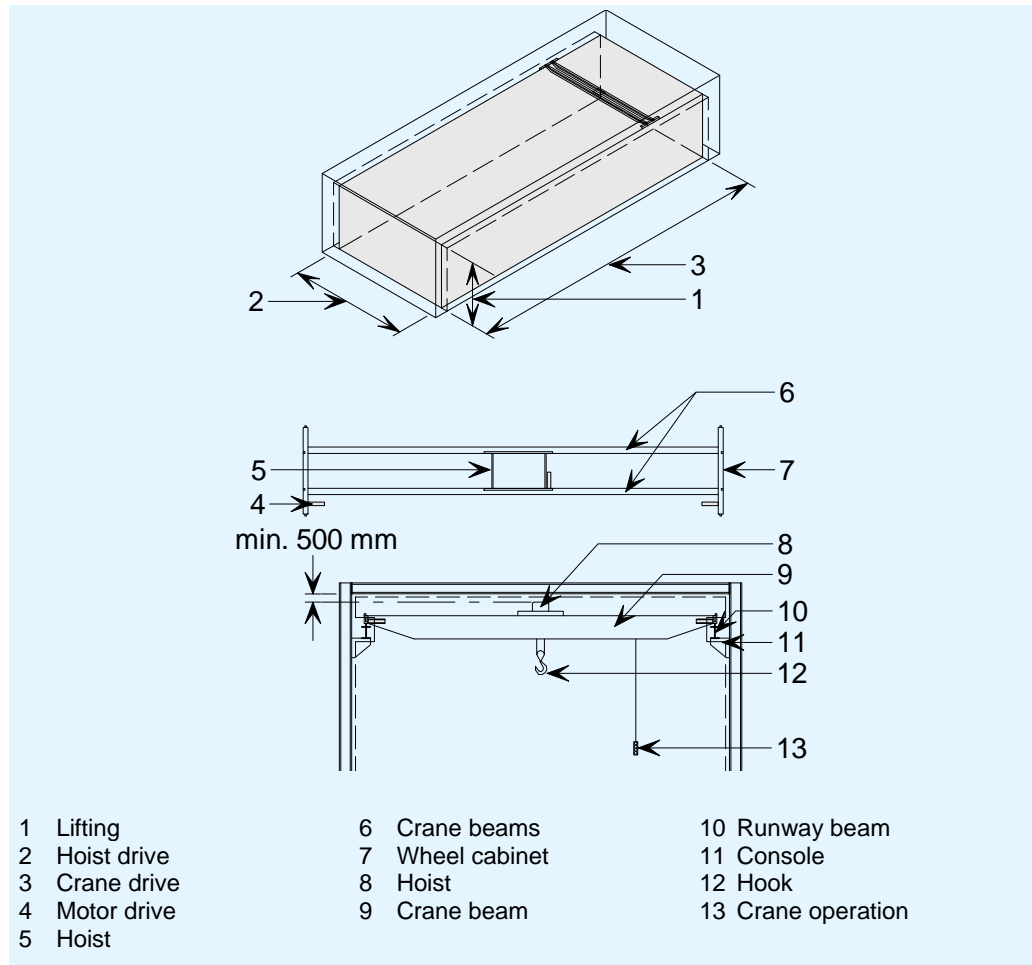

Figure 6.2 Typical overhead crane with gantry and hoist

7 CONCLUSIONS

Steel is a versatile material that allows the architect and engineer to design any type of structure, ranging from orthodox portal frames for industrial use to state of the art buildings with architectural features, unorthodox shapes or any other requirements the stakeholders might have.

Structural steel design is familiar and efficient, providing elegant cost effective solutions. Structural steel can be combined with other materials to achieve the desired look, properties or functionality.

Fabrication of a steel building is carried out in a workshop, ensuring a high quality product and contributing to a low waste, sustainable solution. Standardised details and forms of construction are available which allow fast erection on site, with minimised disruption to the surroundings.

Steel has a very high resistance to weight ratio, resulting in a light, attractive solution with minimal intrusion into the working area of the structure. The transportation of highly prefabricated elements reduces deliveries to site, which is especially important in congested areas, such as city centres. The structural efficiency of steelwork results in lower loads being transferred to the foundations, leading to further economy.

Long span buildings can easily be designed in steel, resulting in large clear areas. This increases the functionality of the structure, offering flexibility of building use. Steel buildings are adaptable and may be easily extended, making refurbishment of the building a realistic solution for future use, instead of demolition.

Steel has excellent sustainability credentials. Steel buildings can easily be dismantled and reused. The steel can always be recycled without any loss of strength, minimising the amount of raw material required.

Steel's low weight, sustainability and versatility, make steel the optimum choice for any type of building.

8 FURTHER READING

Best Practice in Steel Construction: Industrial Buildings, Guidance for Architects, Designers and Constructors

RFCS project deliverable for Euro-Build

Available from the Steel Construction Institute, UK

It can be downloaded from www.eurobuild-in-steel.com